

The logo consists of the letters 'REO' in a white, stylized, sans-serif font. The 'R' and 'E' are connected at the top, and the 'O' is a simple circle. The logo is centered within a solid blue rectangular background.

REO

The text 'REOWAVE® passive' is written in a bold, blue, sans-serif font. It is centered horizontally and positioned in the upper-middle section of the page. The background behind the text is a blurred image of a network patch panel with a green Ethernet port and a blue Ethernet cable plugged in, with concentric circles overlaid to suggest signal waves.

REOWAVE® passive

REOWAVE®passive

The REOWAVE®passive filters the harmonics caused by the B6 circuit (thyristor, diode bridges, etc.) and motor drives on the input side of inverters. The supply grid is relieved by compensation of the harmonic reactive power. This enables costs savings in the selection of material and energy consumption.

Starting currents and current peaks are heavily dampened. This increases the service life and reliability for electrical installations. The compact and ready-to-fit structure assures simple installation, even in existing systems. REOWAVE®passive helps to meet the international power quality standards EN 61000-3 or IEEE 519.

REOWAVE®passive variants

The product is available with protection ratings IP 00 and IP 20, whereby the IP 20 version can also be provided as REOWAVE®passive Plus with two features: the traffic light function and switching off of the absorption circuit when underloaded.

Grid types for REOWAVE®passive

REOWAVE®passive harmonic filters can be supplied for the following grids:

- REOWAVE®passive 400 V / 50 Hz
- REOWAVE®passive 690 V / 50 Hz
- REOWAVE®passive 480 V / 60 Hz
- REOWAVE®passive 600 V / 60 Hz
- REOWAVE®passive 690 V / 60 Hz

Typical applications

Drive technology for motor drives, for example

- Mechanical engineering
- Lifts/Escalators
- Pumps
- Conveying technology
- Ventilation and air conditioning technology
- Robotics
- Automation technology
- Power supplies
- Fail-safe processes
- Applications with a 6-pulse rectifier

Protection rating IP 00

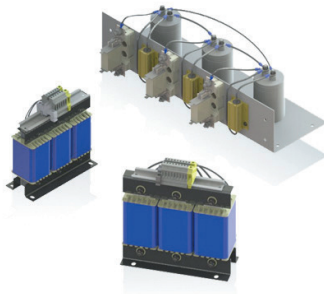

Protection rating IP 20



Service



Training

REO AG is your holistic partner in the area of inductive, resistive and electronic components and full solutions. A wide range of training services are also a key aspect of this partnership. These simplify commissioning of new devices and systems and guarantee hassle-free use during the whole product life cycle. [Training sessions at your site or on the premises of REO AG](#) form the basis for this. Our internal training managers instruct your employees in the technology and provide valuable tips on the correct and safe use of REO components. Our training sessions are available for both standard solutions and high-quality individualised components. Multimedia and easy to understand content supplement the training and also permit international deployment.



Guarantee

Winning quality - extra peace of mind, thanks to the expanded REO manufacturer's guarantee.

We believe in the quality of our own products and are confident of the durability of all components used, which is why we have [extended the legal guarantee from one to two years](#).



Safety

We offer you devices with the highest possible operational safety. Should any unwanted events occur with any of our products, your professional emergency responder will be available to help you over the telephone free of charge. If the situation or query cannot be resolved over the telephone, you have the opportunity to have the defective device sent back after consultation.



Repairs

After telephone consultation, and after the defective product has been received, we can even offer you [express repairs](#) if possible. This minimises downtime in the event of a fault and guarantees a swift exchange.



Hotline

Our REO sales specialists look forward to giving you a helping hand. Contact your REO contact partner or call our hotline to receive further information about our services and the REO portfolio.

REOWAVE®passive

The new generation of harmonic filters	P. 5
Applications and markets	P. 6
Save cash with less reductive power	P. 7
Harmonic filter with the potential for savings	P. 8
REOWAVE®passive - proven REO quality	P. 9
Energy savings of up to 30%	P. 10
REOWAVE®passive energy saving calculator	P. 11
Overcurrent display to check filter action	P. 12
Reductive power optimisation	P. 13
REOWAVE®passive* 400 V / 50 Hz, IP00	P. 14 - 15
REOWAVE®passive* 480 V / 60 Hz, IP00	P. 16 - 17
REOWAVE®passive* 690 V / 50 Hz, IP00	P. 18 - 19
REOWAVE®passive* 400 V / 50 Hz, IP20	P. 20 - 21
REOWAVE®passive* 480 V / 60 Hz, IP20	P. 22 - 23
REOWAVE®passive in IP 00	P. 24
REOWAVE®passive in IP 20	P. 25

The new generation of harmonic filters

Electrical components are becoming increasingly smaller, more efficient and cheaper. To do this, components such as thyristor controllers or inverters are used in most applications. Components are also called "non-linear loads", since their characteristic curve is not linear, which leads to many undesirable problems. These particularly include harmonics.

Harmonics are a type of problem that cannot be initially identified properly in many cases, but that can lead to significant malfunctions, in particular through the increasing use of non-linear loads.

Harmonics cause interference such as:

- The production of additional losses, resulting in unnecessary energy consumption
- The service life of transformers being shortened by destruction of the insulation
- Grid resonances
- Measurement errors
- Faults in triggering of fuses
- Serious IT errors

Advantages

REOWAVE@passive is the solution for these problems! The device is used directly at the location where the problems arise - so exactly where it can have the biggest effect. The circuit between the grid and load eliminates harmonics directly at their source so that they are kept away from the grid and cannot spread to neighbouring electrical installations and damage these.

Image 1: Uncontrolled diode rectifier

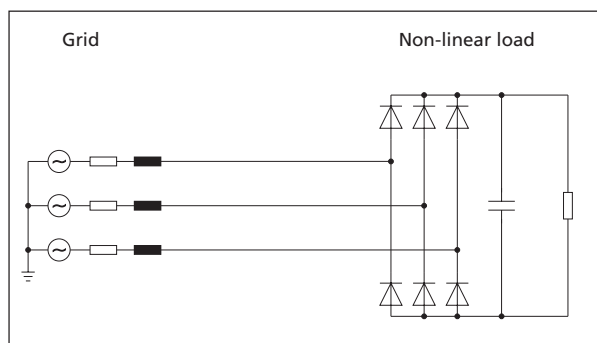

Image 2: Diode rectifier with REOWAVE@passive

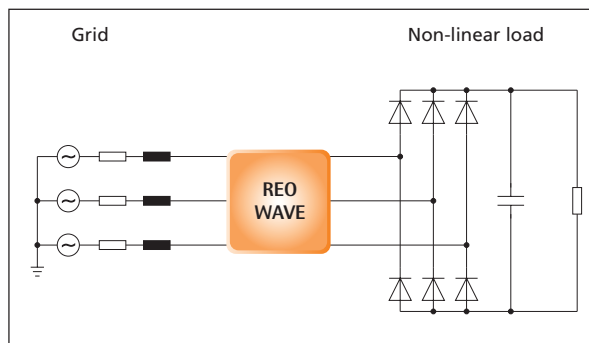

Image 3: Current (blue) and voltage (red) of a B6 circuit with REOWAVE@passive, scaled values

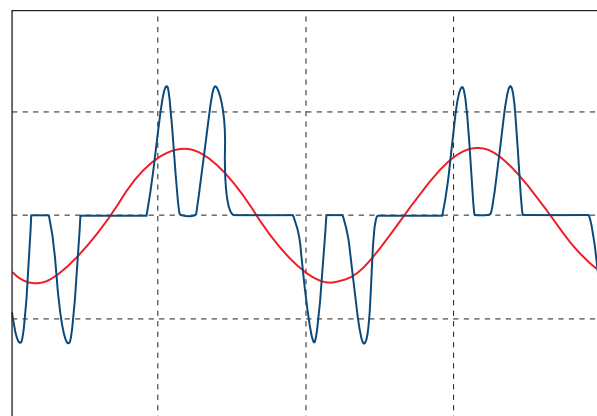
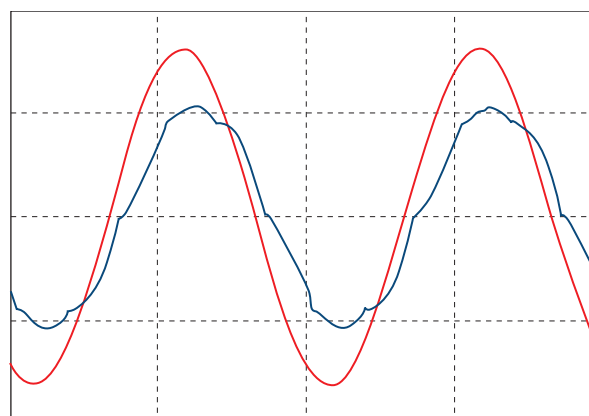

Image 4: Current (blue) and voltage (red) of a B6 circuit with REOWAVE@passive, scaled values



Applications and markets

Refineries and pumps



Renewable energies



Lifts and escalators

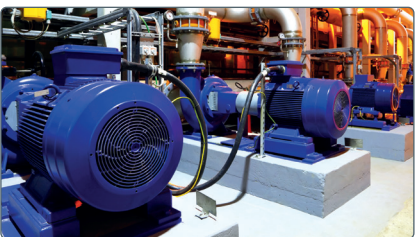

Electric drives



Conveyors

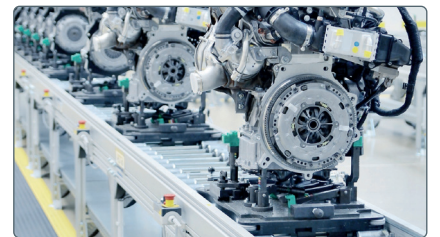

Save cash with less reactive power

In the context of increasing energy costs and growing CO2 emissions, minimising losses in the transmission grid is becoming more important. Reductive currents are a significant factor for this. These currents do not contribute to active power, but strain all components in the current path and cause additional losses on the ohmic resistor of the supply. Reactive currents are also caused by harmonics produced from the use of frequency inverters, for example.

However, the reduction in energy efficiency does not only mean that the environment is polluted. Since more energy

is used for constant power, the costs also increase for the operator because it has to pay for this reactive power.

Mains chokes, DC reactors or harmonic filters from REO filter disruptive harmonics and therefore counteract the reductive current produced. This lowers the amount of reductive power, energy consumption and operating costs.

Measurements on a frequency inverter with 22 kW on the motor shaft

Frequenzumrichter mit 22 kW					
	Without filter	1% UK mains choke	2% UK mains choke	4% UK mains choke	REOWAVE® passive Plus
I_{input} [A]	42,4	41,6	37,7	35,8	32
Q [kvar]	19,6	18,0	15,2	10,2	2,5

Current and power factor on a REOWAVE®passive

CNW 8981 / 6 -1200A / 400V / 50Hz

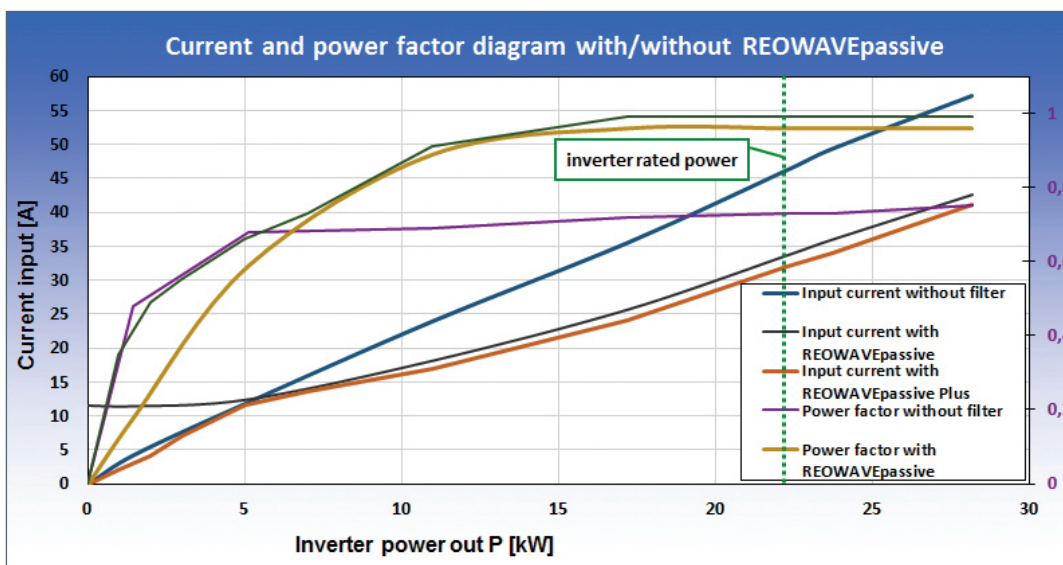

Save up to 30% on energy with REOWAVE®passive!

Harmonic filter with the potential for savings

REOWAVE@passive does not only offer protection against harmonics, as costs can be significantly lowered too. The functioning of the REOWAVE@passive reduces current and current harmonics, meaning fuses, wiring and transformers can be designed to be significantly smaller. In addition to

direct savings on electricity costs, savings can also be made on material costs with REOWAVE@passive. Specifically, this applies if REOWAVE@passive is integrated into the system from the start.

Measurement on an inverter **without** REOWAVE@passive

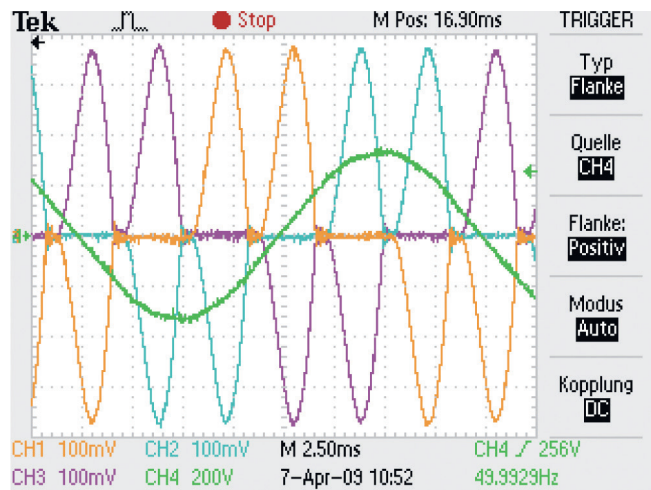

Data	
Power	25,7 A
I5	67 %
I7	43 %
THDI	81%

Measurement on an inverter with REOWAVE@passive

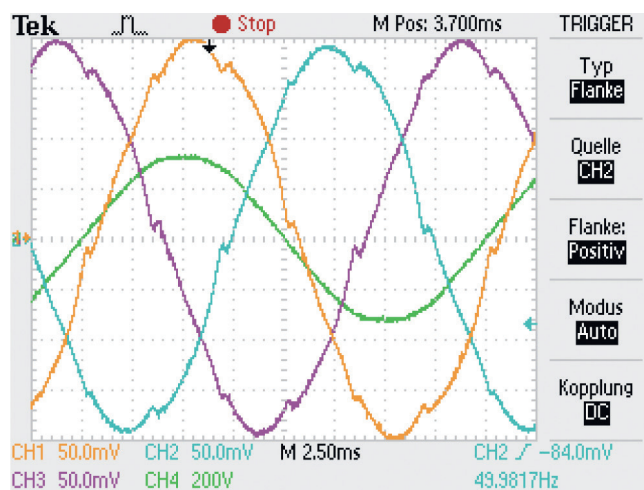

Data	
Power	19,7 A
I5	2,7 %
I7	1,8 %
THDI	4,4

REOWAVE®passive - proven REO quality

REOWAVE®passive does not only protect against harmonics, but costs can be significantly lowered too. The operating principle of the REOWAVE®passive reduces current and harmonics, so that fuses, wiring and transformers can be

designed to be significantly smaller. In addition to direct savings on electricity costs, savings can also be made on material costs with REOWAVE®passive, specifically if REOWAVE®passive is integrated into the system from the start.

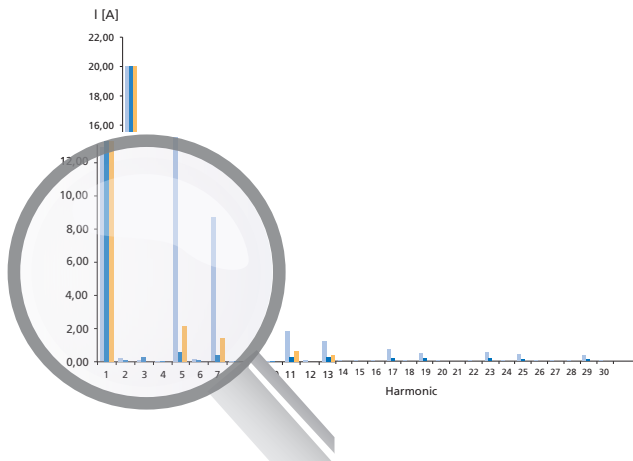

- Inverter is directly in the grid (without REOWAVE®passive)
- Inverter with REOWAVE®passive
- Limit to EN 61000-3-12

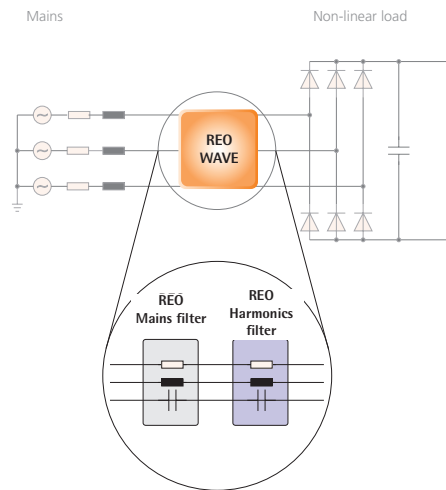

Image 1: The structure also permits parallel connection of two REOWAVE®passive units, to obtain higher performance.

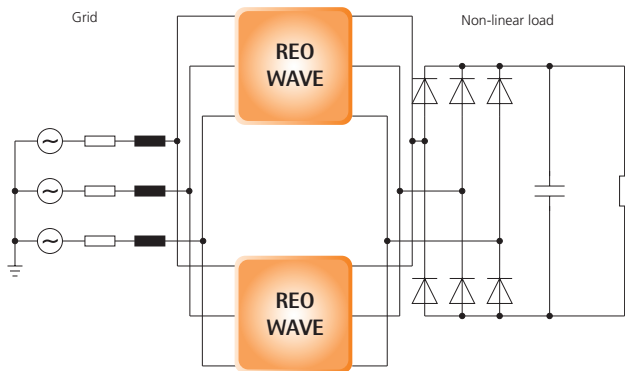
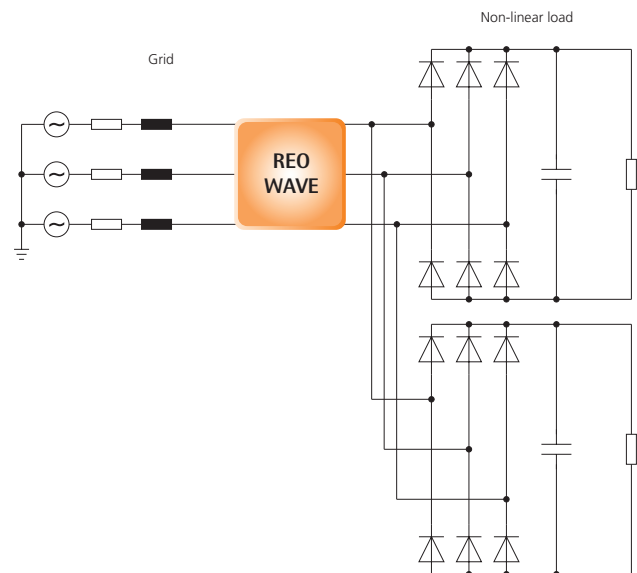

Image 2: Disturbances can also be eliminated in several non-linear loads with one REOWAVE®passive. The filter only needs to have the corresponding power.



Energy savings of up to 30%

REOWAVE@passive filters harmonics and ensures:

- A reduced THDI value
- Improved network stability
- Reduced electricity consumption
- Reduced material costs
- Simple integration into existing systems
- Increased operating safety

REOWAVE@passive



Advantages

- Monitoring and switching off - temperature and filter circuit monitoring
- On-site measurement of grid disturbances
- Tailored power quality solutions

REOWAVE®passive energy saving calculator

Work out your savings with the REOWAVE®passive energy saving calculator.

Savings are calculated with your operating data.



<https://www.reowavepassive.com>

Overcurrent display to check filter action

Increased safety for your installations

What's more, REOWAVE@passive can be supplied to the basic equipment as REOWAVE@passive Plus, including the following additional options:

- Traffic-light function
- Temperature monitoring
- Potential-free signal contacts
- Switching off of the filter function in the event of an error
- Switching off/on of the filter circuit to optimise the reductive power

Advantages

- Traffic-light function
- Temperature monitoring
- Potential-free signal contacts
- Reductive power optimisation

The options should help to better control the grid quality and issue messages to the control centre in the event of faults, meaning you have full control of your power consumption and increase operating safety at the same time.

The load range can be reduced by around 20% with REOWAVE@passive Plus.

Traffic-light function

The REOWAVE@passive Plus includes compact control electronics to monitor mains current and visually display this.

- GREEN** This LED lights when everything is in the green range. The mains currents is ca. 80% of the rated current.
- YELLOW** This LED lights together with the green LED if the mains current is 100% of the rated current.
- RED** This LED lights together with both other LEDs if the mains current is more than 105% of the rated current.

This status is reported via a potential-free contact and can initiate further measures.

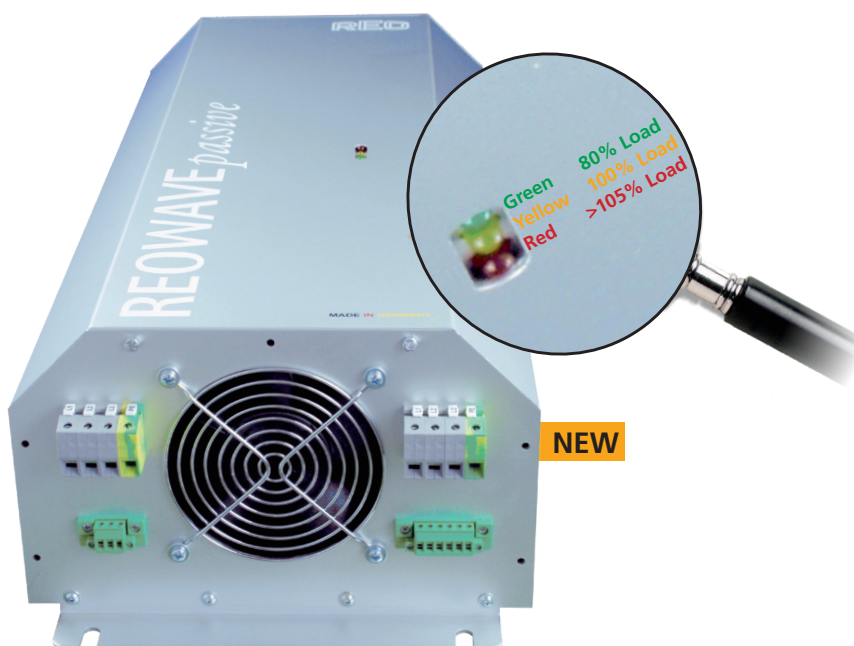

Reductive power optimisation

Reduce individual costs Increase efficiency and operational safety.

Temperature monitoring

The installed chokes also feature temperature monitoring. The installed control technology assesses the choke temperatures. If the operating temperature reaches the set limit temperature, a potential-free contact is switched on.

Switching off of the filter function in the event of an error

If a fault is detected in the temperature monitoring, an internal timer is started. After a time set internally expires (3 minutes), the filter circuit is separated from the grid to prevent further disturbances. All error messages are reset if the mains current returns to the valid range of ca. 100% of the rated current.

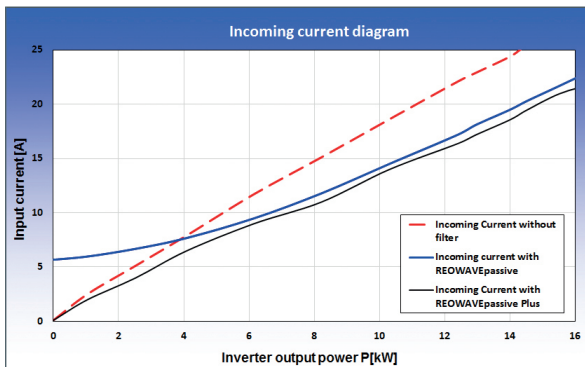

Reductive power optimisation

The filter circuit is initially switched on with specific current to optimise the reductive power. The reductive current proportion is prevented by the filter choke.

Suitable plugs and sockets are available as options for instant use without large installations, meaning that savings can be made immediately!

A specially developed control logic in the REOWAVE@passivePlus increases efficiency and operational safety. Firstly, this logic permits the filter circuit to be protected in the event of overtemperature and overload. Secondly, the absorption circuit is taken from the grid in the starting mode of the frequency inverter to minimise the reductive power and protect the filter capacitors.

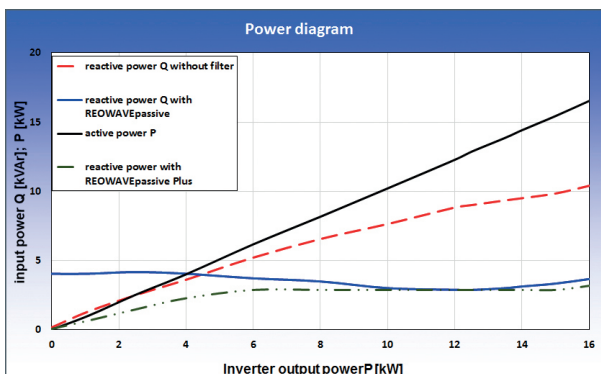
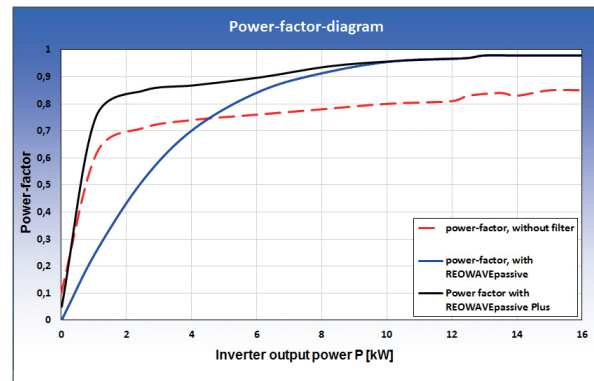

Operating principle of the REOWAVE@passive Plus

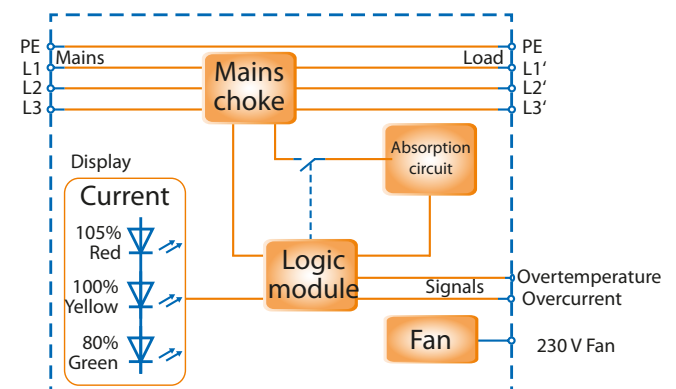

REOWAVE®passive* 400 V / 50 Hz

Electrical and mechanical data

- Insulation class: F
- Climate class: 25/085/21 DIN IEC 68 Part 1
- Ambient temperature: 40° C
- Protection rating: IP 00 - The components are supplied as separate components for installation by the customer

Technical data

REOWAVE®passive* 400 V / 50 Hz																					
Image No.	CNW type/ Choke1/ Choke2	Rated current [A]	Loss [W]	Mains choke 1 [mm]					Absorber circuit choke 2 [mm]					Capacitors [mm]						Total weight [kg]	
				L	B1/ B2	H	N1	N2	L	B	H	N1	N2	L	B	H	N1	N2	N3		N4
1/4	8981/6	6	95	190	82	210	170	58	125	85	125	100	55	500	200	100	450	470	100	-	12,5
1/4	8981/9	9	120	190	92	210	170	68	155	77	155	130	57	500	200	100	450	470	100	-	16,2
1/4	8981/12	12	120	190	92	210	170	68	155	92	185	130	72	500	260	230	450	470	100	-	17,5
2/4	8981/16	16	160	230	90	258	176	71	190	82	210	170	58	500	200	100	450	470	100	-	25
2/4	8981/22	22	230	230	114	260	176	95	190	82	210	170	58	500	350	100	450	470	100	125	31,4
2/4	8981/32	32	241	240	117	270	185	95	210	97	238	175	77	500	200	230	450	470	100	125	42,9
2/4	8981/36	36	300	240	132	270	185	109	210	97	238	175	77	500	200	230	450	470	100	125	42,5
1/4	8981/45	45	313	300	120	335	224	94	210	107	238	175	87	500	200	100	450	470	100	-	57,1
3/4	8981/55	55	420	300	152	330	224	119	210	117	238	175	97	500	350	200	450	470	100	125	59,8
3/4	8981/70	70	487	300	165	330	224	132	230	114	260	176	95	500	260	230	450	470	100	-	67,3
3/4	8981/90	90	580	360	193	330	264	167	230	114	263	176	95	500	260	100	450	470	100	-	81,8
3/6	8981/110	110	710	420	189	367	316	159	240	122	280	185	100	500	350	230	450	470	100	125	110,5

*All variants are also available as REOWAVE®passive Plus

REOWAVE®passive* 400 V / 50 Hz			
Image No.	CNW type Choke1/ Choke2	Rated current [A]	Loss [W]
3/6	8981/800	800	2510
3/6	8981/1000	1000	2650
3/6	8981/1200	1200	3030

A special structure is required for this due to the particular design so **please contact us about this!**

Technical data

REOWAVE®passive* 400 V / 50 Hz																						
Image No.	CNW type Choke1/ Choke2	Rated current [A]	Loss [W]	Mains choke 1 [mm]					Absorber circuit choke 2 [mm]					Capacitors [mm]						Total weight [kg]		
				L	B1/ B2	H	N1	N2	L	B	H	N1	N2	L	B	H	N1	N2	N3		N4	
3/6	8981/145	145	860	420	204	369	316	174	265	133	270	200	103	500	350	230	450	470	100	125	130	
3/6	8981/180	180	1000	420	234	368	316	204	300	135	315	224	107	500	260	200	450	470	100	-	160	
3/6	8981/200	200	1100	420	234	369	316	204	300	150	280	224	120	500	260	400	450	470	100	-	167	
3/6	8981/230	230	950	480	220	417	356	184	300	170	280	224	135	500	350	100	450	470	100	125	180	
3/6	8981/270	270	1140	480	250	416	356	214	360	223	310	264	142	500	200	300	450	470	100	-	226	
3/6	8981/33	330	1570	480	250	465	356	214	360	223	310	264	142	500	370	160	450	470	100	125	249	
3/6	8981/370	370	1680	480	250	467	356	214	420	206	364	316	143	500	500	160	450	470	100	275	259	
3/6	8981/400	400	1410	480	250	464	356	214	420	204	363	316	143	500	370	400	450	470	100	125	266	
3/6	8981/450	450	1500	480	250	510	356	214	420	220	363	316	158	500	550	160	450	470	100	275	296	
3/6	8981/550	550	1850	480	250	506	356	214	420	235	364	316	174	500	550	160	450	470	100	275	310	
3/6	8981/650	650	2090	480	250	589	356	214	420	268	363	316	204	500	550	510	450	470	100	275	369	

*All variants are also available as REOWAVE®passive Plus

REOWAVE®passive* 480 V / 60 Hz

Electrical and mechanical data

- Insulation class: F
- Climate class: 25/085/21 DIN IEC 68 Part 1
- Ambient temperature: 40° C
- Protection rating: IP 00 - The components are supplied as separate components for installation by the customer

Technical data

REOWAVE®passive* 480 V / 60 Hz																					
Image No.	CNW type Choke1/ Choke2	Rated current [A]	Loss [W]	Main choke 1 [mm]					Absorber circuit choke 2 [mm]					Capacitors [mm]						Total weight [kg]	
				L	B1/ B2	H	N1	N2	L	B	H	N1	N2	L	B	H	N1	N2	N3		N4
1/4	8981/9	9	120	190	92	210	170	68	155	77	155	130	57	500	200	100	450	470	100	-	16,2
1/4	8981/12	12	120	190	92	210	170	68	155	92	185	130	72	500	260	230	450	470	100	-	17,5
1/4	8981/16	16	160	230	90	258	176	71	190	82	210	170	58	500	200	100	450	470	100	-	25
2/4	8981/22	22	230	230	114	260	176	95	190	82	210	170	58	500	350	100	450	470	100	125	31,4
2/4	8981/32	32	241	240	117	270	185	95	210	97	238	175	77	500	200	230	450	470	100	125	40,4
2/4	8981/36	36	300	240	132	270	185	109	210	97	238	175	77	500	200	230	450	470	100	125	41,5
1/4	8981/45	45	313	300	120	335	224	94	210	107	238	175	87	500	200	100	450	470	100	-	55,1
3/4	8981/55	55	420	300	152	330	224	119	210	117	238	175	97	500	350	200	450	470	100	125	57,8
3/4	8981/70	70	487	300	165	330	224	132	230	114	260	176	95	500	260	230	450	470	100	-	67,3
3/4	8981/90	90	580	360	193	330	264	167	230	114	263	176	95	500	260	100	450	470	100	-	81,8
3/6	8981/110	110	710	420	189	367	316	159	240	122	280	185	100	500	350	230	450	470	100	125	107,5
3/6	8981/145	145	860	420	204	369	316	174	265	133	270	200	103	500	350	230	450	470	100	125	128

*All variants are also available as REOWAVE®passive Plus

REOWAVE@passive* 480 V / 60 Hz			
Image No.	CNW type Choke1/ Choke2	Rated current [A]	Loss [W]
3/6	8981/800 3/3	800	2510
3/6	8981/1000 3/3	1000	2650
3/6	8981/1200 3/3	1200	3030

A special structure is required for this due to the particular design so **please contact us about this!**

Technical data

REOWAVE@passive* 480 V / 60 Hz																						
Image No.	CNW type Choke1/ Choke2	Rated current [A]	Loss [W]	Main Choke1 [mm]					Absorber circuit choke 2 [mm]					Capacitors [mm]						Total weight [kg]		
				L	B1/ B2	H	N1	N2	L	B	H	N1	N2	L	B	H	N1	N2	N3		N4	
3/6	8981/180	180	1000	420	234	368	316	204	300	135	315	224	107	500	260	200	450	470	100	-	157	
3/6	8981/200	200	1100	420	234	369	316	204	300	150	280	224	120	500	260	400	450	470	100	-	165	
3/6	8981/230	230	950	480	220	417	356	184	300	170	280	224	135	500	350	100	450	470	100	125	175	
3/6	8981/270	270	1140	480	250	416	356	214	360	223	310	264	142	500	200	300	450	470	100	-	223	
3/6	8981/330	330	1570	480	250	465	356	214	360	223	310	264	142	500	370	160	450	470	100	125	243	
3/6	8981/370	370	1680	480	250	467	356	214	420	206	364	316	143	500	500	160	450	470	100	275	252	
3/6	8981/400	400	1410	480	250	464	356	214	420	204	363	316	143	500	370	400	450	470	100	125	257	
3/6	8981/450	450	1500	480	250	510	356	214	420	220	363	316	158	500	550	160	450	470	100	275	284	
3/6	8981/550	550	1850	480	250	506	356	214	420	235	364	316	174	500	550	160	450	470	100	275	298	
3/6	8981/650	650	2090	480	250	589	356	214	420	268	363	316	204	500	550	510	450	470	100	275	357	

*All variants are also available as REOWAVE@passive Plus

REOWAVE®passive* 690 V / 50 Hz

Electrical and mechanical data

- Insulation class: F
- Climate class: 25/085/21 DIN IEC 68 Part 1
- Ambient temperature: 40° C
- Protection rating: IP 00 - The components are supplied as separate components for installation by the customer

Technical data

REOWAVE®passive* 480 V / 60 Hz																						
Image No.	CNW type Choke1/ Choke2	Rated current [A]	Loss [W]	Main choke 1 [mm]					Absorber circuit choke 2 [mm]					Capacitors [mm]						Total weight [kg]		
				L	B1/ B2	H	N1	N2	L	B	H	N1	N2	L	B	H	N1	N2	N3		N4	
1/4	8981/9	9	170	240	107	265	185	85	155	92	185	130	72	500	200	100	450	470	100	-	28	
1/4	8981/12	12	210	240	117	265	185	95	190	82	210	170	58	500	200	100	450	470	100	-	31	
1/4	8981/16	16	230	240	127	265	185	105	190	92	210	170	68	500	260	230	450	470	100	-	39	
2/4	8981/22	22	230	300	122	330	224	94	190	92	210	170	68	500	200	100	450	470	100	-	48	
2/4	8981/32	32	290	300	147	330	224	119	240	97	265	185	75	500	350	100	450	470	100	125	70	
2/4	8981/36	36	310	300	162	330	224	134	240	97	270	185	75	500	200	230	450	470	100	125	73	
1/4	8981/45	45	380	300	173	335	224	145	240	107	270	185	85	500	200	230	450	470	100	125	84	
3/4	8981/55	55	510	360	168	312	264	142	240	107	275	185	85	500	200	100	450	470	100	-	91	
3/4	8981/70	70	650	420	174	367	316	144	240	122	275	185	100	500	350	200	450	470	100	125	98	
3/4	8981/90	90	860	420	189	369	316	159	300	135	330	224	107	500	260	230	450	470	100	-	111	
3/6	8981/110	110	810	420	239	366	316	209	300	135	335	224	107	500	260	100	450	470	100	-	164	
3/6	8981/145	145	1130	480	234	418	356	198	300	135	345	224	107	500	350	230	450	470	100	125	187	

*All variants are also available as REOWAVE®passive Plus

Technical data

REOWAVE®passive* 690 V / 50 Hz																					
Image No.	CNW type Choke1/ Choke2	Rated current [A]	Loss [W]	Main choke 1 [mm]					Absorber circuit choke 2 [mm]					Capacitors [mm]						Total weight [kg]	
				L	B1/ B2	H	N1	N2	L	B	H	N1	N2	L	B	H	N1	N2	N3		N4
3/6	8981/180	180	1190	480	234	418	356	198	300	173	310	224	145	500	350	230	450	470	100	125	200
3/6	8981/200	200	1400	480	244	414	356	208	360	183	315	264	157	500	260	200	450	470	100	-	229
3/6	8981/230	230	1410	480	264	413	356	228	360	193	315	264	167	500	260	400	450	470	100	-	256
3/6	8981/270	270	1490	540	289	460	450	199	360	219	309	264	177	500	350	100	450	470	100	125	308
3/6	8981/330	330	1840	540	299	461	450	209	420	268	362	316	219	500	200	300	450	470	100	-	360
3/6	8981/370	370	1830	540	309	461	450	219	480	266	415	356	208	500	370	160	450	470	100	125	407
3/6	8981/400	400	2040	540	314	461	450	224	480	280	413	356	228	500	500	160	450	470	100	275	434
3/6	8981/450	450	2110	540	319	517	450	229	480	289	414	356	238	500	370	400	450	470	100	125	473
3/6	8981/500	500	2440	540	324	518	450	234	480	295	416	356	238	500	550	160	450	470	100	275	487
3/6	8981/600	600	2330	550	284	594	450	248	480	295	416	356	238	500	550	160	450	470	100	275	570

*All variants are also available as REOWAVE®passive Plus. On inquiry also as protection rating IP 20

REOWAVE®passive* 400 V / 50 Hz

Electrical and mechanical data

- Insulation class: F
- Climate class: 25/085/21 DIN IEC 68 Part 1
- Ambient temperature: 40° C
- Protection rating: IP 20 – various housing shapes depending on power

Technical data

REOWAVE®passive* 400 V / 50 Hz													
Image No.	CNW type Choke1/ Choke2	Main choke [A]	Loss [W]	Housing dimensions in mm								Weight [kg]	Clamp [mm ²]
				L	B	H/H1	H2	N1	N2	N3	D		
4	CNW 8981/6	6	95	570	240	175	-	545	150	-	9	20	10
4	CNW 8981/9	9	120	570	240	175	-	545	150	-	9	25	10
4	CNW 8981/12	12	120	570	240	175	-	545	150	-	9	30	10
5	CNW 8981/16	16	160	670	275	175	-	645	200	-	9	35	10
5	CNW 8981/22	22	230	670	275	175	-	645	200	-	9	40	10
5	CNW 8981/32	32	241	820	340	175	-	795	250	-	9	50	10
5	CNW 8981/36	36	300	820	340	175	-	795	250	-	9	50	10
6	CNW 8981/45	45	313	1000	360	260	-	925	298	50	13	65	16
6	CNW 8981/55	55	420	1000	360	260	-	925	298	50	13	65	16
6	CNW 8981/70	70	487	1000	360	260	-	925	298	50	13	80	16
7	CNW 8981/90	90	580	765	475	520	-	675	316	-	13	125	50
7	CNW 8981/110	110	710	765	475	520	-	675	316	-	13	175	50

*All variants are also available as REOWAVE®passive Plus

REOWAVE®passive* 400 V / 50 Hz		
Image No.	CNW type Choke1/ Choke2	Main choke [A]
9	CNW 8981/800	800
9	CNW 8981/1000	1000
9	CNW 8981/1200	1200

A special structure is required for this due to the particular design so
please contact us about this!

Technical data

REOWAVE®passive* 400 V / 50 Hz													
Image No.	CNW type Choke1/ Choke2	Main choke [A]	Loss [W]	Housing dimensions in mm								Weight [kg]	Clamp [mm ²]
				L	B	H/H1	H2	N1	N2	N3	D		
7	CNW 8981/145	145	860	765	475	520	-	675	316	-	13	200	50
8	CNW 8981/180	180	1000	600	600	1800	200	-	-	-	-	340	-
8	CNW 8981/200	200	1100	600	600	1800	200	-	-	-	-	345	-
8	CNW 8981/230	230	950	600	600	1800	200	-	-	-	-	352	-
8	CNW 8981/270	270	1140	600	600	1800	200	-	-	-	-	370	-
8	CNW 8981/330	330	1570	600	600	2000	200	-	-	-	-	427	-
8	CNW 8981/370	370	1680	600	600	2000	200	-	-	-	-	427	-
8	CNW 8981/400	400	1410	600	600	2000	200	-	-	-	-	442	-
8	CNW 8981/450	450	1500	600	600	2000	200	-	-	-	-	473	-
8	CNW 8981/550	550	1850	800	800	2000	200	-	-	-	-	540	-
8	CNW 8981/650	650	2090	800	800	2000	200	-	-	-	-	597	-

*All variants are also available as REOWAVE®passive Plus

REOWAVE®passive* 480 V / 60 Hz

Electrical and mechanical data

- Insulation class: F
- Climate class: 25/085/21 DIN IEC 68 Part 1
- Ambient temperature: 40° C
- Protection rating: IP 20 – various housing shapes depending on power

Technical data

REOWAVE®passive* 480 V / 60 Hz												
Image No.	CNW type Choke1/ Choke2	Main choke [A]	Loss [W]	Housing dimensions in mm							Weight [kg]	Clamp [mm ²]
				L	B	H/H1	H2	N1	N2	D		
4	CNW 8981/9	9	120	570	240	175	-	545	150	9	25	10
4	CNW 8981/12	12	120	570	240	175	-	545	150	9	30	10
5	CNW 8981/16	16	160	670	275	175	-	645	200	9	35	10
5	CNW 8981/22	22	230	670	275	175	-	645	200	9	40	10
5	CNW 8981/32	32	241	820	340	175	-	795	250	9	50	10
5	CNW 8981/36	36	300	820	340	175	-	795	250	9	50	10
6	CNW 8981/45	45	313	1000	360	260	-	925	298	13	65	16
6	CNW 8981/55	55	420	1000	360	260	-	925	298	13	65	16
6	CNW 8981/70	70	487	1000	360	260	-	925	298	13	80	16
7	CNW 8981/90	90	580	765	475	520	-	675	316	13	125	50
7	CNW 8981/110	110	710	765	475	520	-	675	316	13	175	50
7	CNW 8981/145	145	860	765	475	520	-	675	316	13	200	50

*All variants are also available as REOWAVE®passive Plus

REOWAVE®passive* 480 V / 60 Hz

REOWAVE®passive* 400 V / 50 Hz		
Image No.	CNW type Choke1/ Choke2	Main choke [A]
9	CNW 8981/800	800
9	CNW 8981/1000	1000
9	CNW 8981/1200	1200

A special structure is required for this due to the particular design so **please contact us about this!**

Technical data

REOWAVE®passive* 480 V / 60 Hz												
Image No.	CNW type Choke1/ Choke2	Main choke [A]	Loss [W]	Housing dimensions in mm							Weight [kg]	Clamp [mm ²]
				L	B	H/H1	H2	N1	N2	D		
8	CNW 8981/180	180	1000	600	600	1800	200	-	-	-	340	-
8	CNW 8981/200	200	1100	600	600	1800	200	-	-	-	345	-
8	CNW 8981/230	230	950	600	600	1800	200	-	-	-	352	-
8	CNW 8981/270	270	1140	600	600	1800	200	-	-	-	370	-
8	CNW 8981/330	330	1570	600	600	2000	200	-	-	-	427	-
8	CNW 8981/370	370	1680	600	600	2000	200	-	-	-	427	-
8	CNW 8981/400	400	1410	600	600	2000	200	-	-	-	442	-
8	CNW 8981/450	450	1500	600	600	2000	200	-	-	-	473	-
8	CNW 8981/550	550	1850	800	800	2000	200	-	-	-	540	-
8	CNW 8981/650	650	2090	800	800	2000	200	-	-	-	597	-

*All variants are also available as REOWAVE®passive Plus

REOWAVE®passive in IP 00

Image 1

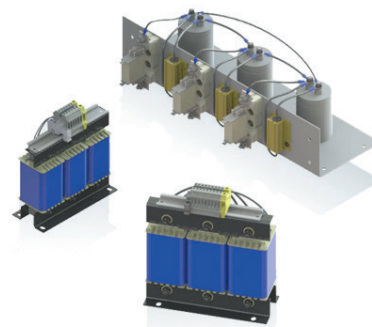
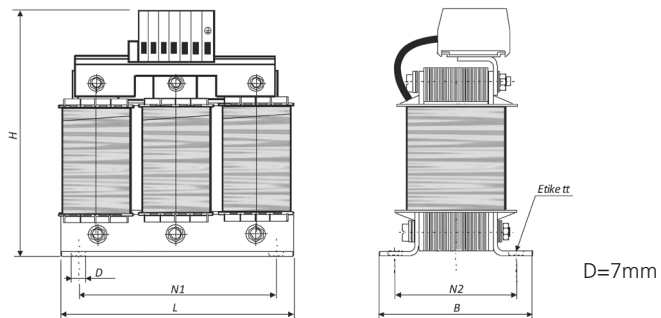

Image 2

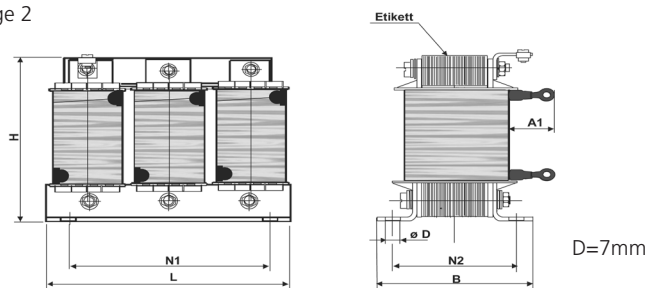
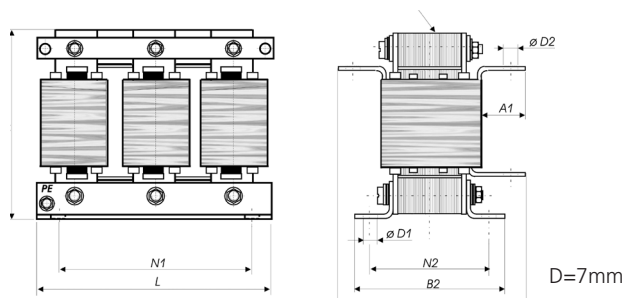
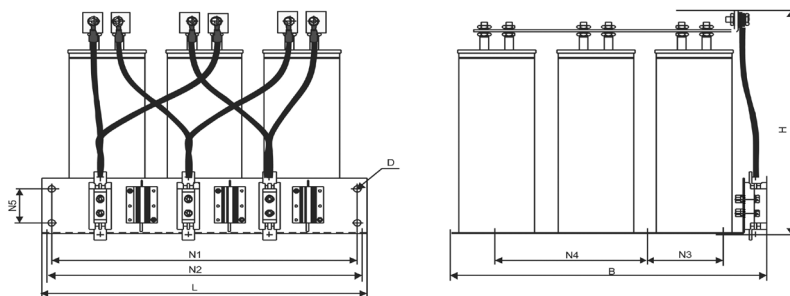

Image 3



Capacitors



REOWAVE®passive in IP 20

Image 4

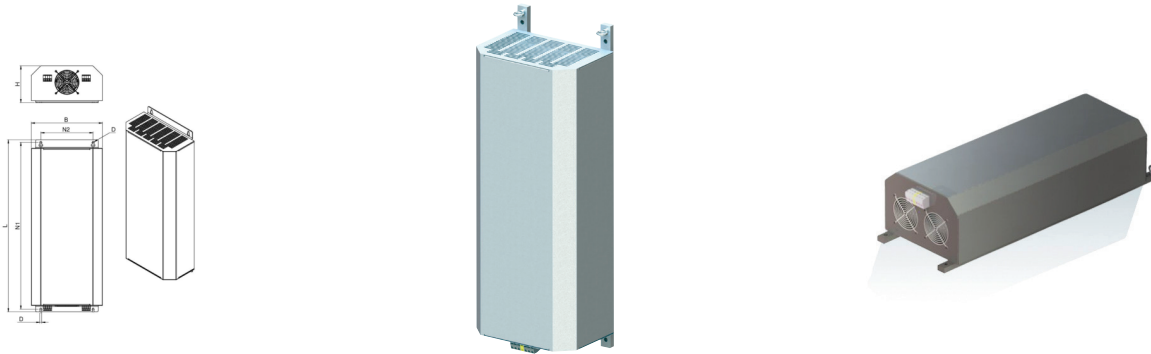

Image 5

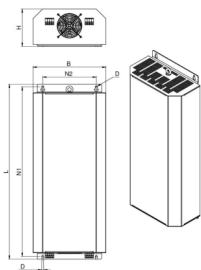

Image 6

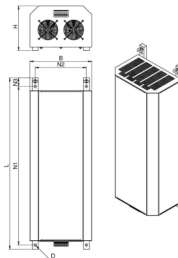

Image 7

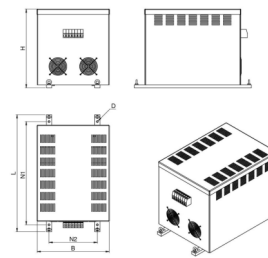

Image 8

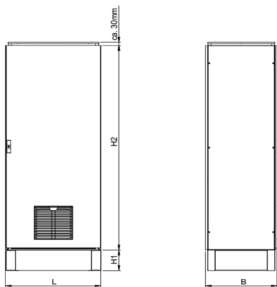
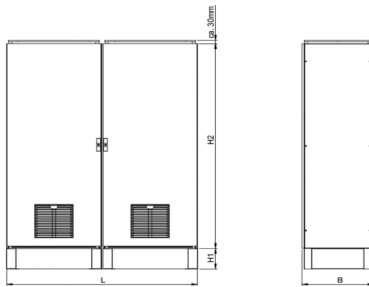

Image 9



REO AG
Brühler Straße 100 · D-42657 Solingen
Phone: +49 (0)212 8804 0 · Fax: +49 (0)212 8804 188

Email: info@reo.de
Internet: www.reo.de



DIVISIONS:

REO Vibratory Feeding and Power Electronics Division

Brühler Straße 100 · D-42657 Solingen
Phone: +49 (0)212 8804 0 · Fax: +49 (0)212 8804 188
Email: info@reo.de

REO Train Technologies Division

Erasmusstraße 14 · D-10553 Berlin
Phone: +49 (0)30 3670236 0 · Fax: +49 (0)30 3670236 10
Email: zentrale.berlin@reo.de

REO Drives Division

Holzhausener Straße 52 · D-16866 Kyritz
Phone: +49 (0)33971 485 0 · Fax: +49 (0)33971 485 90
Email: zentrale.kyritz@reo.de

REO Medical and Current Transformer Division

Schuldholzinger Weg 7 · D-84347 Pfarrkirchen
Phone: +49 (0)8561 9886 0 · Fax: +49 (0)8561 9886 40
Email: zentrale.pfarrkirchen@reo.de

REO Test and PowerQuality Division

Brühler Straße 100 · D-42657 Solingen
Phone: +49 (0)212 8804 0 · Fax: +49 (0)212 8804 188
Email: info@reo.de

PRODUCTION + SALES:

India

REO GPD INDUCTIVE COMPONENTS PVT. LTD
Email: info@reogpd.com · Internet: www.reo-ag.in

USA

REO-USA, Inc.
Email: info@reo-usa.com · Internet: www.reo-usa.com

SALES:

China

REO Shanghai Inductive Components Co., Ltd
Email: info@reo.cn · Internet: www.reo.cn

France

REO VARIAC S.A.R.L.
Email: reovariac@reo.fr · Internet: www.reo.fr

Great Britain

REO (UK) Ltd.
Email: main@reo.co.uk · Internet: www.reo.co.uk

Italy

REO ITALIA S.r.l.
Email: info@reoitalia.it · Internet: www.reoitalia.com

Poland

REO CROMA Sp.zo.o
Email: croma@croma.com.pl · Internet: www.croma.com.pl

Spain

REO ESPAÑA 2002 S.A.
Email: info@reospain.com · Internet: www.reospain.com

Switzerland

REO ELEKTRONIK AG
Email: info@reo.ch · Internet: www.reo.ch

Turkey

REO TURKEY ELEKTRONIK San. ve Tic. Ltd. Şti.
Email: info@reo-turkey.com · Internet: www.reo-turkey.com